

Figure 5.

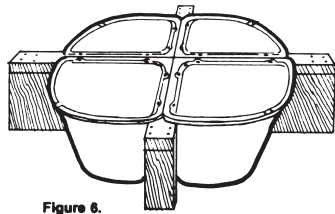
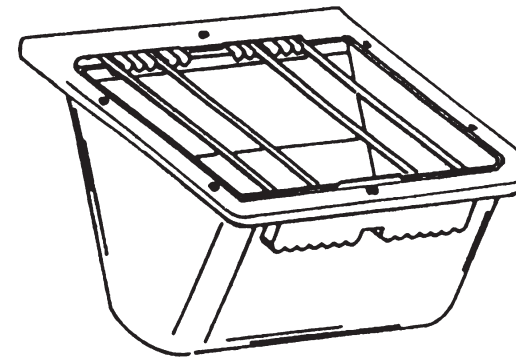

Figure 6.



DURAFLEX BUCKETS, TUBS AND FEEDERS

This booklet contains installation instructions for the DuraFlex Foal Feeder and DuraFlex Corner Feeder.



PF25 FOAL FEEDER

Available in Blue only

MILLER MFG. CO. WARRANTY Miller Mfg. Co. Products are warranted to the original purchaser to be free from defects in material and workmanship under normal use and service. Miller's obligation under this Warranty shall be limited to the repair or exchange of any part or parts which may thus prove defective under normal use and service within 30 days from the date of shipment by Miller to the original purchaser, and which Miller's examination shall disclose to its satisfaction to be thus defective. Purchaser must deliver any part or parts to Miller Mfg. Co., 1450 West 13th Street, Glencoe, MN 55336, for examination. THIS WARRANTY IS EXPRESSLY IN LIEU OF ALL OTHER WARRANTIES EXPRESSED OR IMPLIED INCLUDING THE WARRANTIES OF THE MERCHANTABILITY AND FITNESS FOR USE AND ALL OTHER OBLIGATIONS OR LIABILITIES ON OUR PART. WE NEITHER ASSUME, NOR AUTHORIZE ANY OTHER PERSON TO ASSUME FOR US, ANY OTHER LIABILITY IN CONNECTION WITH THE SALE OF MILLER PRODUCTS OR ANY PART THEREOF WHICH HAS BEEN SUBJECT TO ACCIDENT, NEGLIGENCE, ALTERATION, ABUSE OR MISUSE. WE MAKE NO WARRANTY WHATSOEVER IN RESPECT TO ACCESSORIES OR PARTS NOT SUPPLIED BY US.

For additional Little Giant products visit
www.miller-mfg.com

MILLER MFG. CO. 1450 West 13th Street • Glencoe, MN 55336 USA
(651) 982.5100 • Fax (651) 982.5101 • www.miller-mfg.com

PCF6 CORNER FEEDER

Available in Red, Blue, Green
and Black

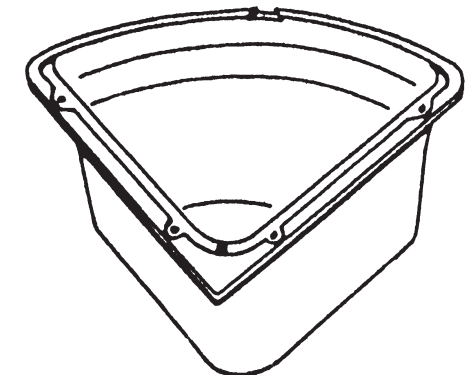



#PF25 DuraFlex Foal Feeder

- Your Foal Feeder comes complete with mounting plate, adjustable bars, bar retainer ring, and drain plug. Mounting hardware is not included.
- The ideal location for your Foal Feeder is near a corner in the stall or corral. This prevents the horse from frequently bumping the feeder.
- The feeder should be mounted no less than 3 feet from the ground to the bottom mounting holes in feeder.
- Your PF25 Foal Feeder can be attached to three different mounting surfaces as follows:

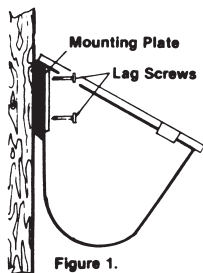

Figure 1. Wood Walls

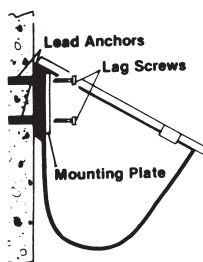

Figure 2. Concrete Walls

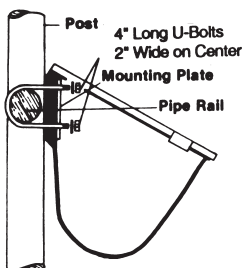

Figure 3. Pipe Corral

Remove bar retainer ring and adjustable bars from feeder. Using four 5/16 x 3' lag screws and socket wrench, place four lag screws through mounting plate, on inside of feeder and tighten until reinforcement ribs on back of feeder begin to flex slightly.

Using mounting plate as a template to mark, drill four 1/2" dia. holes into concrete approximately 2" deep. Insert 4 lead anchors into drilled holes. Mount feeder to four anchors with 5/16 x 3" lag screws.

To mount to pipe corral use 4" long U bolts 2" wide on center and mount feeder to pipe rail (cut ends of U bolt off and smooth if necessary.) (Please note: to gain additional support place feeder in front of vertical post when mounting. This will prevent feeder from twisting downward when horse puts pressure on front of feeder.)

- When replacing bar retainer ring after cleaning or mounting be sure to check that all six screws are securely tightened.
- Adjusting cross bars: To adjust cross bars, remove all six screws from bar retainer ring, and remove retainer ring. Proper setting of the cross bars may take more than one adjustment until you have determined which setting is wide enough for the foal to enter the feeder and narrow enough to keep the mares out.

Replacement Parts

ITEM NO.	DESCRIPTION
PF1	FEEDER TROUGH ONLY
PF2	ADJUSTABLE BAR
PF3	MOUNTING PLATE
PF5	DRAIN PLUG

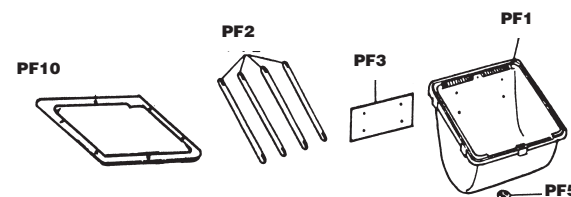

PCF6 DuraFlex Corner Feeder

- The Dura-Flex CORNER FEEDER can be mounted in your stall by two different methods.
 - A. Anchor two pieces of 2 X 4 blocks, approx. 20" long, in the corner of your stall as shown in figure 4. Place CORNER FEEDER snugly into corner over 2 X 4 blocks. Mounting holes should be centered over 2 X 4 blocks. Use four lag screws to fasten feeder to anchoring blocks.

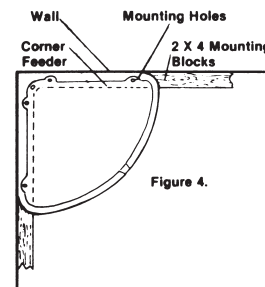

Figure 4.

- B. An optional tub mounting ring (#CF1) is available for the PCF6 as well as a feed saver ring. (#CF2) See figure 5.
- C. Four DuraFlex CORNER FEEDERS mounted on crossed 4 X 4 members makes an excellent four place feeder. See figure 6.